

Technical Specifications

Princeton PB80+



PRINCETON
DELIVERY SYSTEMS®



Princeton PB80+ Technical Specifications

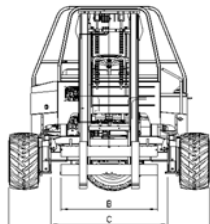
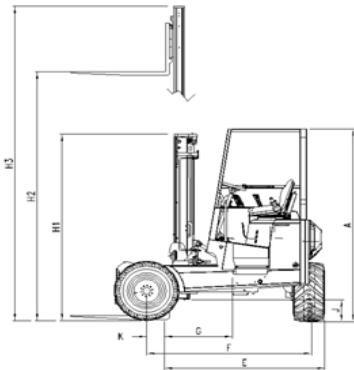

	Model	PB80+
	TYPE	Standard
1	CAPACITY @ 24" LOAD CENTER	8000 lbs
2	DIESEL ENGINE	56 HP
3	ENGINE EMISSION COMPLIANCE	EPA Tier4 Final
4	MAXIMUM RPM	2700 RPM
5	ELECTRICAL SYSTEM	12 Volt
6	DRIVE WHEELS	3
7	STEERING	Hydrostatic
8	TIRE TYPE	31 x 15.5 - 15 12-Ply (RT)
		31 x 15.5 - 15 12-Ply (RT)
9	TIRE OUTSIDE DIAMETER	31"
10	TIRE WIDTH	15.5"
11	MAXIMUM SPEED	7 mph
12	MAXIMUM GRADABILITY	30%
13	TURNING RADIUS	91"
14	UNLADEN WEIGHT	6970 lbs
14a	UNLADEN WEIGHT (OPTIONAL)	N/A
15	WORKING PRESSURE (ATTACHMENTS)	2500 psi
16	TILT OF MAST (FORWARD/BACKWARD)	10° / 8°
17	SIDESHIFT	5"
18	FORK SECTION	48 x 6 x 2"
19	MAST CARRIAGE TRAVEL	27"
A	HEIGHT TO TOP OF CANOPY	101"
B	FORK CARRIAGE WIDTH (CLASS)	48.25" (III)
C	FRAME OPENING	57.75"
D	OVERALL WIDTH	101"
E	OVERHANG	80"
F	WHEELBASE	83.5"
G	CENTER OF GRAVITY (FROM FORK FACE)	27"
H1	LIFT HEIGHT	144"
H2	MAST HEIGHT - COLLAPSED	109.25"
H3	MAST HEIGHT - RAISED	181"
H1a	LIFT HEIGHT	N/A
H2a	MAST HEIGHT - COLLAPSED	N/A
H3a	MAST HEIGHT - RAISED	N/A
J	GROUND CLEARANCE	11"
K	FACE OF FORK TO CENTER OF FRONT TIRE	9"
L	ANSI STANDARD	B56.14

The above specifications are not binding upon the manufacturer and may be changed without prior notice.

Weights may vary, depending on tire and/or fork options

For more information, contact your local PiggyBack Dealer

PRINCETON

DELIVERY SYSTEMS®

Princeton Delivery Systems

12233 Williams Road

Perrysburg, OH 43551 USA

tel 1.800.331.5851

www.piggy-back.com

A Part of the Hiab Group
V2017.10.20